

**CyberView
User's**

**X5 SF
Manual**

ENGLISH

FEDERAL COMMUNICATIONS COMMISSION (FCC) STATEMENT

This Equipment has been tested and found to comply with the limits for a class B digital device, pursuant to Part 15 of the FCC rules. These limits are designed to provide reasonable protection against harmful interference in a residential installation. This equipment generates uses and can radiate radio frequency energy and, if not installed and used in accordance with the instructions, may cause harmful interference to radio communications. However, there is no guarantee that interference will not occur in a particular installation. If this equipment does cause harmful interference to radio or television reception, which can be determined by turning the equipment off and on, the user is encouraged to try to correct the interference by one or more of the following measures:

- Re-orient or relocate the receiving antenna.
- Increase the separation between the equipment and receiver.
- Connect the equipment into an outlet on a circuit different from which the receiver is connected to.
- Consult the dealer or an experienced radio/TV technician for help.

Warning :

Use only shielded signal cables to connect I/O devices to this equipment. You are cautioned that changes or modifications not expressly approved by the party responsible for compliance could void your authority to operate the equipment.

TABLE OF CONTENTS

Getting Started	4
Quick Installation Guide (QIG)	5
Installing Software and Driver	6
Installing Hardware	8
Additional Features	8
Loading the film/slides into the Holders	9
One Button Scan	11
How to Scan Slides	12
STEP 1 - Acquire Driver	12
STEP 2- Select Film Type	12
STEP 3 - Optional Prescan	12
STEP 4 - Set Scan Settings	13
STEP 5 - Set Scan Preferences	14
STEP 6 - Scan	17
STEP 7 - Exit	17
User Interface	18
I Main Window Area	18
II Preview Window Area	20
III Scan Setting Area	25
Technical Support	26

GETTING STARTED

Check the package content before getting started.
For Quick Installation please refer to Quick Installation Guide. (Ref. Pg. 9)



Important! Save the original box, receipt and packing material for future shipping needs.

Package Contents

- Slide Scanner.
- Film Holder (Where Applicable)
- Power Adapter [FAIRWAY Model No. : WRG 15F-120A]



Warning! Using any other power adapter may severely damage the scanner and will void the product warranty.

- Power Cord.
- USB 2.0 Cable.
- CyberView X5 Driver.
- Application software DVD.
- Printed User's Manual.

NOTE:

- Application software means the imaging software such as Adobe® Photoshop® Elements, this is subject to change without notice.

GENERAL GUIDANCE:

- Only use the supplied USB-Cable. Connect the computer to the scanner directly using the USB 2.0 cable.
- Do not use a hub or extension cable. Only use the USB ports on the rear of desktop computers.
- If there are any other devices (multifunction device, printers, scanners, webcam) connected to the computer through USB, disconnect them.
- A minimum of 1GB RAM (Win/Mac) is required.

Operating Ambient Temperature Range 50° to 104°F (10° to 40°C)

Note: Do not turn on the scanner unless it is within this range. If the scanner has been stored or transported outside of this range, allow it to return to within this range before turning it on.

Operating Ambient Humidity Range 15% to 76% relative humidity (non-condensing)

Note: If the scanner is stored or to be transported in cold temperature and then brought into a warm / humid environment condensation may occur.

This device is designed solely for private use and is not intended for commercial use. The warranty is reduced from 2 years to 1 year if errors or defects arising from inappropriate use, improper operation or stress occur. The guarantee period of the device for private use is 2 years or 20,000 scans.

QUICK INSTALLATION GUIDE (QIG)

WINDOWS SYSTEMS INSTALLATION DURING DRIVER INSTALLATION A WARNING DIALOGUE BOX MAY APPEAR, IF THIS IS THE CASE PLEASE SELECT "INSTALL THIS DRIVER ANYWAYS".



Be sure to install the Application Software BEFORE installing the scanner driver CyberView X 5.0.

You may install the scanner driver directly if you have already installed TWAIN compliant application software in your computer. Mac users can use iPhoto for editing.

Notice:

1. In "Found New Hardware Wizard" window, select "Search automatically or Browse computer for driver software."
2. In "Completing the Found New Hardware Wizard" window, click "Finish".

NOTE: Not all PC's will display the found new hardware window, some will install in the background

INSTALLING SOFTWARE AND DRIVER

Before Installing the Scanner Driver...

If you choose to use the provided application for image editing, install the application software (ex: Adobe® Photoshop® Elements) by inserting the application CD into the computer's CD/DVD drive. Follow the instructions that will be displayed in a window that opens automatically.

Installing Scanner Driver

- a. Insert insert driver CD into the computer CD/DVD drive and explore the contents.
- b. Double click the "CyberView X 5.0" icon to begin the installation process. Follow the onscreen prompts to complete the installation process.

NOTE: Make sure the scanner is NOT connected to the computer during the CyberView X 5.0 driver installation.

- c. Restart computer once the installation process is complete.

Please Note: When installing your new scanner onto a Windows system that already has another USB Flatbed scanner or All-in-one Scan/Copier/Printer device installed, it may be necessary for you to disconnect the other scanner from the USB port for the Film scanner to work properly,

TWAIN scanner plug-in Installation Guide for Adobe Photoshop Elements 9 and newer versions

The TWAIN scanner plug-in is no longer installed with Photoshop Elements 9. In order to be able to import scanner device through Adobe Photoshop elements, please follow below instructions after installing Adobe Photoshop Elements 9 to find where and how to install the TWAIN component which was previously installed with the application for versions earlier than Photoshop Elements 9.

Important: Do not move plug-ins from previous versions of Photoshop Elements into the Photoshop Elements 9 > Plug-Ins folder, or set the Photoshop Elements 8 (or earlier) > Plug-In folder as the Additional Plug-Ins Folder in Preferences.

Find complete information at official Adobe website:
http://kb2.adobe.com/cps/849/cpsid_84933.html

Macintosh

To install the legacy TWAIN plug-in for Macintosh, copy TWAIN.plugin folder from: //Applications/Adobe Photoshop Elements 9/Optional Plug-Ins/Import-Modules/

Into: //Applications/Adobe Photoshop Elements 9/Locales/<locale>/Plug-Ins/

Windows

To install the legacy TWAIN plug-in for Windows, copy twain_32.8ba from: C:\Program Files\Adobe\Photoshop Elements 9\Optional Plug-Ins\Import-Export\

Into: C:\Program Files\Adobe\Photoshop Elements 9\Locales\<locale>\Plug-Ins\Import-Export\

64-bit Windows

Photoshop Elements 9 is a 32-bit application. When installed on a 64-bit version of Windows the path is slightly modified.

To install the legacy TWAIN plug-in for Windows, copy twain_32.8ba from: C:\Program Files (x86)\Adobe\Photoshop Elements 9\Optional Plug-Ins\Import-Export\

Into: C:\Program Files (x86)\Adobe\Photoshop Elements 9\Locales\<locale>\Plug-Ins\Import-Export\

Installing Hardware

a. Connect the slide scanner to a power source.

1. Locate the power switch on the lower left side of the scanner. Make sure the scanner is TURNED OFF.



2. Plug the AC adapter into an AC power source FIRST before plugging it into the scanner.

3. Attach the USB cable to the computer using the standard USB adapter end. Attach the USB adapter end of the cable to back panel of the scanner.

Additional features

CrystalScan 7200

1. Lid.
2. Slide Holder
3. Film Deck
4. One Button Scan
5. Release Switch
6. Viewing Window.

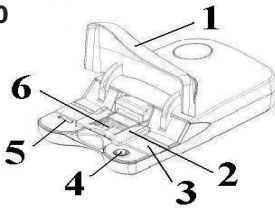

1. DC In
2. USB Port
3. Power Switch



ProScan 7200

1. Scanner
2. Slide holder
3. Film Holder
4. One Button Scan
5. Back of the unit
6. Viewing Window

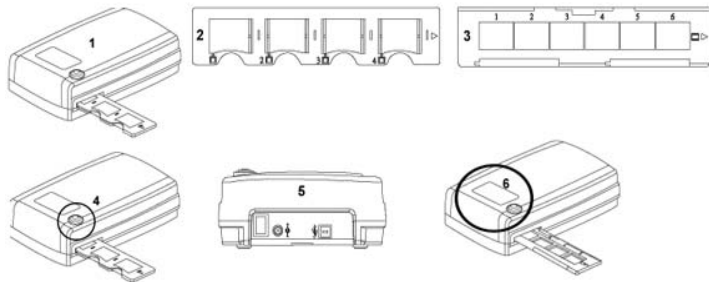

To Scan Film (Film & Mounted Slides) CrystalScan 7200

Mounted Slides

1. Open Scanner Lid (1).
2. Release the Slide/Film Holder (5) put in slide "Shiny side up" then close slide holder.
3. Close Scanner Lid (1) (optional).
4. Ready to scan.

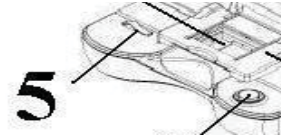

Filmstrips

1. Open the scanner lid (1).
2. Release the Slide Holder (5).
3. Position the film that you wish to scan in the center of the viewing window (6).
4. Push down the film frame and close the slide holder.
5. Ready to scan.

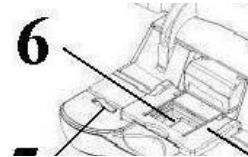

ProScan7200

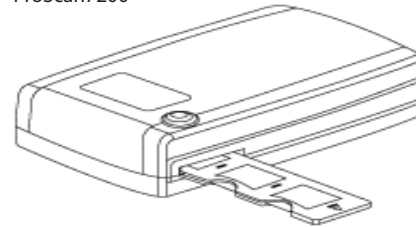

To Scan Mounted Slides

1. Mounted Slides

- 1-1. Load the mounted slides into the slide holder, shiny side facing upward
- 1-2. Insert the slide holder into the scanner with the arrow facing upwards
- 1-3. Insert to holder into the scanner from the left or the right side

ProScan 7200 - Scanning Slides (Continued...)

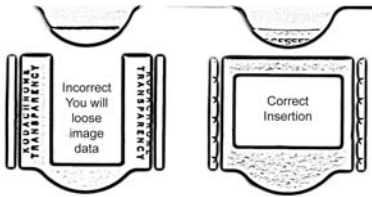

Please Note: improper insertion will cut off the top of the image.

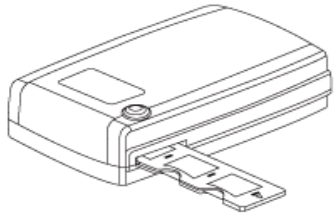

To Scan Negative Film Strips

2-1. Load the negative into the holder making sure to align the film frames with the frames on the holder, and with the shiny side facing upward

2-2 Close the film holder

2-3. Insert the film holder into the scanner from the left or right side, with the arrow facing upwards

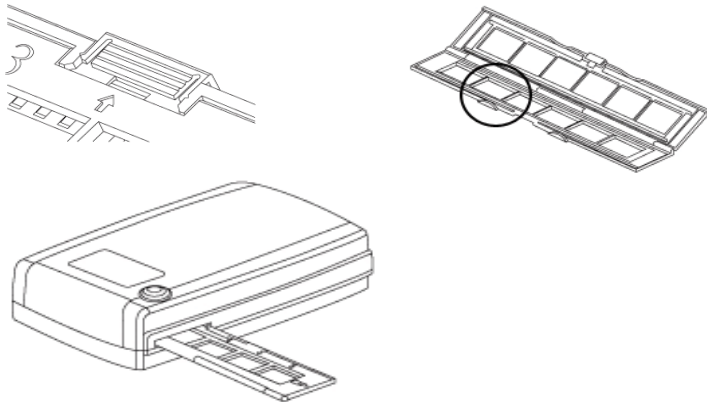

One Button Scan

1. Open the CyberView (see page 12 to acquire the CyberView driver program)
2. Configure Scan Settings (see Page 13)
3. Select the Scan to directory, file format (TIF or JPG, once configured, Press the scanner button ) to begin scanning.

CrystalScan 7200 One Touch Button

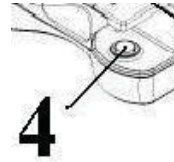

ProScan 7200 One Touch Button

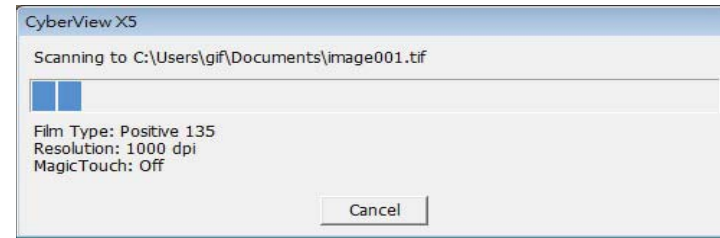
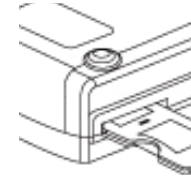

NOTE: If you do not open CyberViewX 5.0 FIRST, the scan button will not function.

HOW TO SCAN SLIDES

STEP 1 – Acquire Driver

(For PC User)

Open CyberView X 5 from Start – All Programs –CyberView

(For MAC User)

Open Macintosh Hard drive – Applications –CyberView

STEP 2 – Select Film Type

Select the film type to be scanned - Positive, Negative or B&W (Black and White).



STEP 3 – Optional Prescan

Select the “Prescan Current Frame” to prescan the slide currently loaded into the scanner or “Prescan...” to prescan slide or slides at specific positions in the magazine.

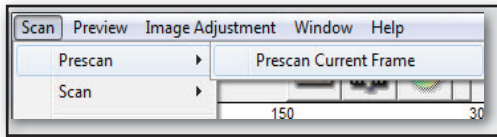

Pre-Scanning should be used to manually adjust color/edit settings for each slide before doing the final scan. It's possible to set different settings for each slide to be scanned.

STEP 4 – Set Scan Settings

a. Resolution

The default scanning resolution is 1000dpi, additional resolution options are listed below.

Notice: Higher scanning resolutions result in greater scanning time and hardisk space requirements.

b. Color Depth

Choose between 8 and 16bit. A higher color depth setting will result in a larger range of colors in the final scanned image.

The Film Scanner colour depth is 48 bit true color. The scanning software has the capability of selecting 8 bit color mode or 16 bit color mode when scanning, This will produce 24 or 48 bit color images, 8 bits or 16 bits per Red, Green and Blue color channels.

Example:

8 bit mode = 8 Red, 8 Green, and 8 Blue for a total of 24 bit color

16 bit mode = 16 Red, 16 Green, and 16 Blue for a total of 48 bit color

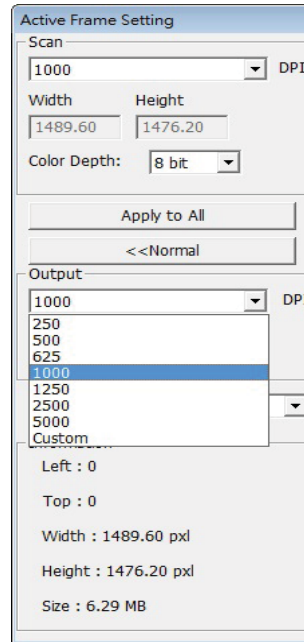

NOTE: Make sure there is enough space available on the computer when changing the Scanning Resolution. A high scanning resolution results in large files that may prove difficult to save.

Color image file size of different resolutions and color depths:

Scanning Resolution	Color Depth (by RGB channel)	Color Mode	File Size TIFF (no compression)
300dpi	8 bit	24-bit	~350Kb
600dpi	8 bit	24-bit	~1MB
1800dpi	8 bit	24-bit	~12MB
3600dpi	8 bit	24-bit	~52MB
7200dpi	8 bit	48-bit	~208MB

Scans include Auto Balance and Digital Noise Reduction on:

Processor: AMD 9650 Quad-Core 2.3GHz
 Memory: 2GB
 System type: Vista 64 bit

Scan Mode – Normal mode produces a scan in jpeg format while Quality produces a non-compressed, “loss-less” TIFF image.

STEP 5 – Set Scan Preferences

Select Scan - Preference - Film Type - Scan Setting

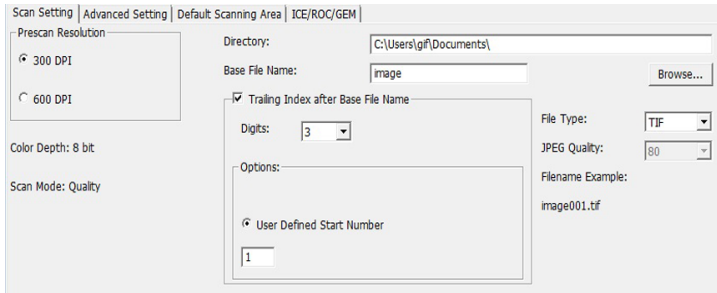
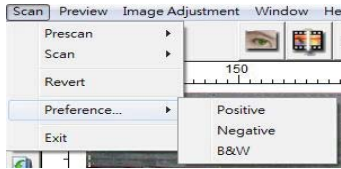

“Prescan Resolution” - Default pre-scan resolution.

“Using default real scan resolution” - Enables default scan resolution setting.

“Color Depth” – Default color depth while scanning.

“Scan Mode” – Default scan mode while scanning.

Configuring Scan Preferences

1. Select Browse and choose the designated folder to save the scanned image to
2. Enter the file name.

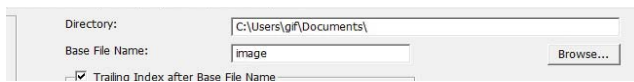

3. Trailing Index after Base File Name Digits: Defines the length of the file name and numbering sequence up to 6 digits Example image1 or image000001.

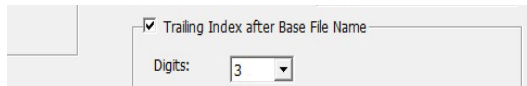

Set Scan Preferences (Continued...)

4. Options - Use Film Index: Use the number assigned to the slide based on it's position in the cartridge.

User Defined Start Number: Enter a specific start number

5. Choose the file type, “TIF” or “JPG”. (TIF uncompressed or JPG Compressed- Choose image quality for JPEG. (20-100) 100 offers the least amount of compression



Advanced Setting - PC Users

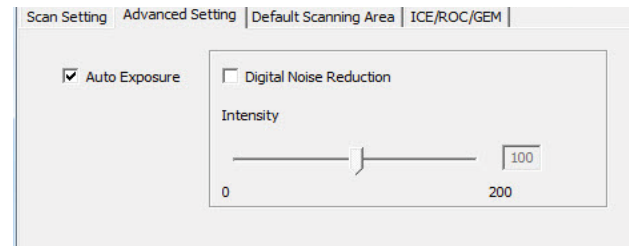

Advanced Setting - Intel Mac Users

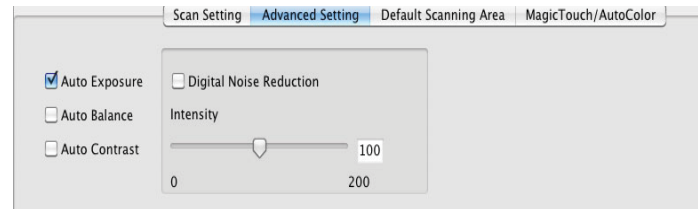

“Auto Exposure” - Attempts to find the correct exposure to get the widest range of whites and blacks while putting the middle grays at around the middle of the data range.

“Auto Balance” - Using the image histogram to balance RGB channels. It estimates images' color cast and adjust the images accordingly

“Auto Contrast” - The scanner software analyzes the data and automatically adjusts the Setting for the White and Black Points.

“Digital Noise Reduction” – Applies a filter, Reducing the film grain.

Default Scanning Area

Adjust the scanning size as well as adjust the "Scan Offset" setting to move the image position of slide.

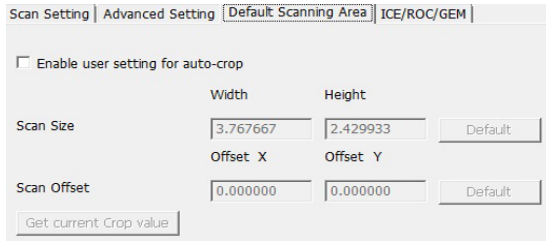

CS7200 - Windows and Mac PowerPC Users ONLY- Digital ICE, ROC, GEM (for additional information, please see included Digital ICE³ Users guide)

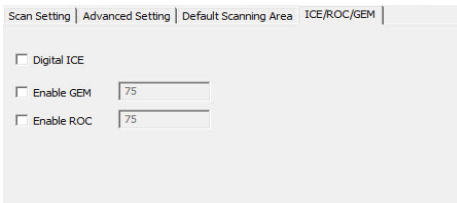

Intel Based Mac Users - Magic Touch / Auto Color
Enable / disable Magic Touch and Auto Color adjustment to scans.

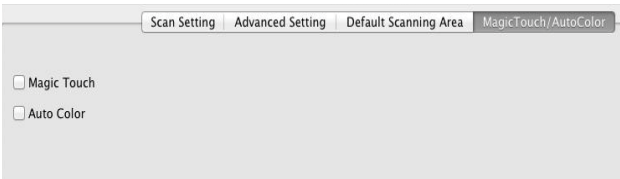

Magic Touch is a powerful dust and scratch removal technology that does away with the hassle of learning complex and tedious software techniques. Being hardware-based, it works seamlessly with the scanning process to ensure the best possible results when bringing images into the computer. Dust, scratches and other flaws are intelligently detected and eliminated, restoring the image to its original beauty.

Scanning with Magic Touch requires longer scanning times, the feature is turned off by default.

Auto Color takes the guesswork out of the scanning process to streamline the workflow and achieve the best results. Proprietary color enhancement technology is applied to scanned images to provide the most accurate color adjustment, resulting in vibrant images with optimal brightness, contrast and saturation.

STEP 6 – Scan

Scan - Scan- Scan Current Frame

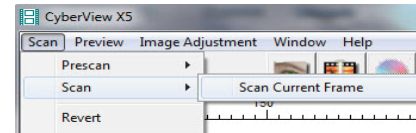

This begins the scan to file process

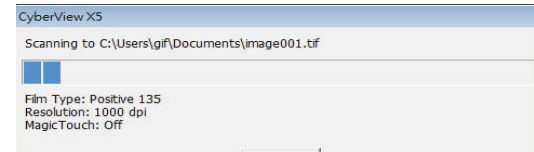

All scanned images will be saved to the directory location set previously, the factory default locations are:

- Windows:** C:\Users\[YOUR NAME]\Documents;
- MAC:** Mac HD\Users\[YOUR NAME]\Pictures\Cyberview Images),

STEP 7 – Exit

Select "Scan > Exit" to close the driver. Scanned image files can be open/edited with any image editing software.

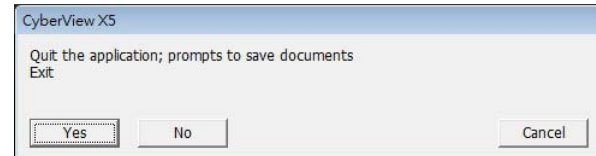

NOTE: If using the supplied image editor, for help with this application see the users Help from within the application or browse the supplied DVD for the help documentation.

USER INTERFACE

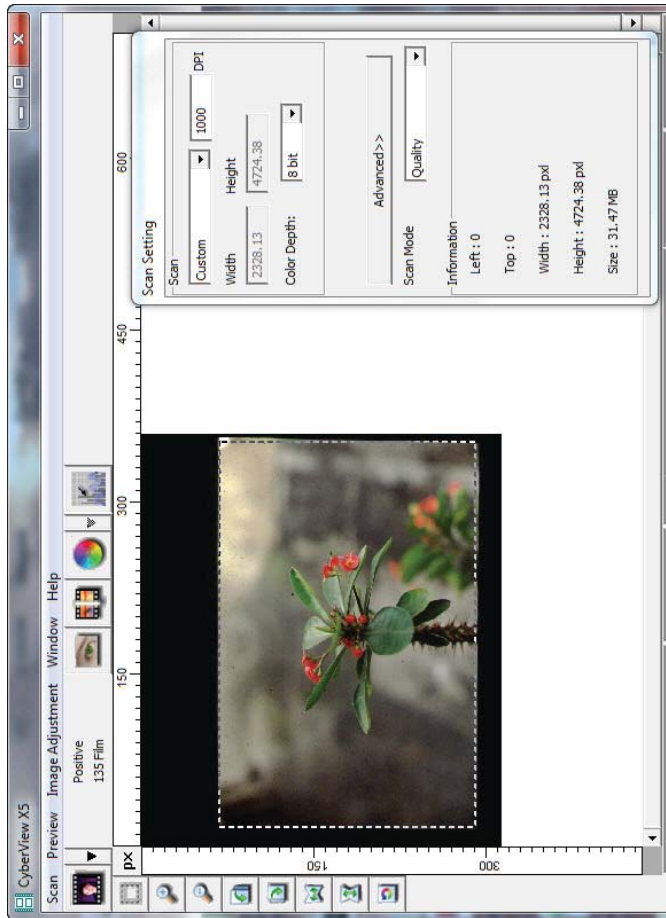

There are four major parts of the CyberView X 5 user interface:

- I. Main Window Area [Fixed Windows]
- II. Preview Window Area [Fixed Window]
- III. Scan Setting Area [Floating Window]

I. Main Window Area [Fixed Windows]

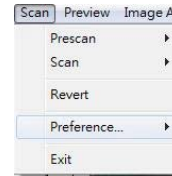

Menu Commands - Scan

Prescan - Prescan Current Frame: Pre-scan the existing slide.

Scan - Scan Current Frame > Scan the current slide.

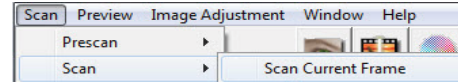

Menu Commands - Preview

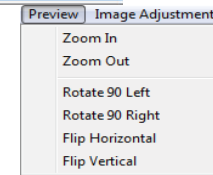

Zoom, Rotate & Flip features.

Revert

Discards all modifications and restores the image back to the original state.

Preference - See Scan Setting (See Page 13)

Exit

Closes the CyberView X5 user interface.

There is a message pop-up "Quit the application prompts to save documents?" click "Yes" to save, "No" to discard the current settings or "Cancel" to return to Cyber View X.

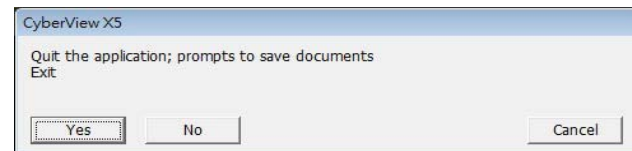

Menu Commands - Image Adjustment

a. Image Adjustment

1. Variations: Generates different views of image with options to make changes to highlights, midtones, etc.

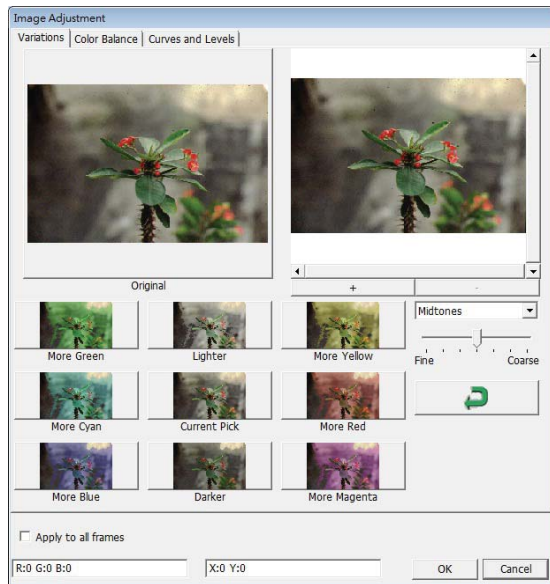
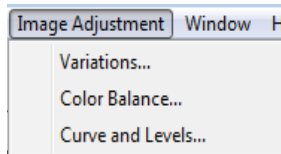

2. Color Balance

To adjust the brightness, contrast, saturation, and color (CMY or RGB) of the image. Comparisons between before and after adjusted images are shown for reference.

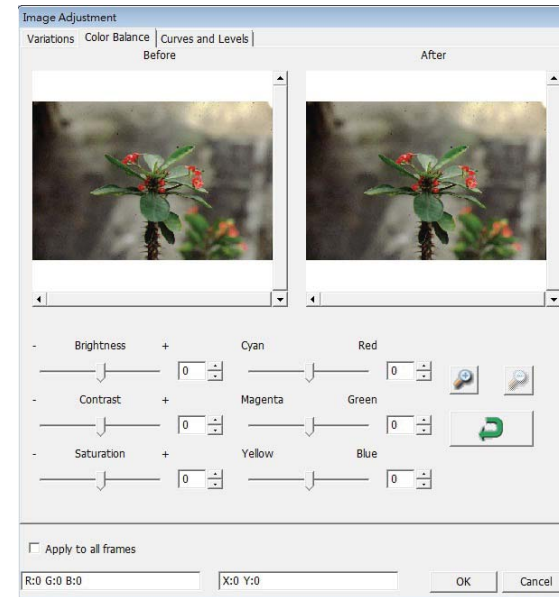

Example: If a previewed image appears too dark, use the "Brightness" slider in the "Color Balance" window to adjust the image by selecting the slider in the center and moving it to the right. The image's "After" view becomes lighter. Select "OK" to accept the changes which will be sent to the scanning hardware. This can also be used to adjust each of the functions in "Color Balance" by contrast, saturation and specific color ranges of cyan, magenta and yellow.

3. Curves and Levels

Adjust image settings by moving Curve and Levels settings. Comparison between before and after adjustment is displayed for reference.

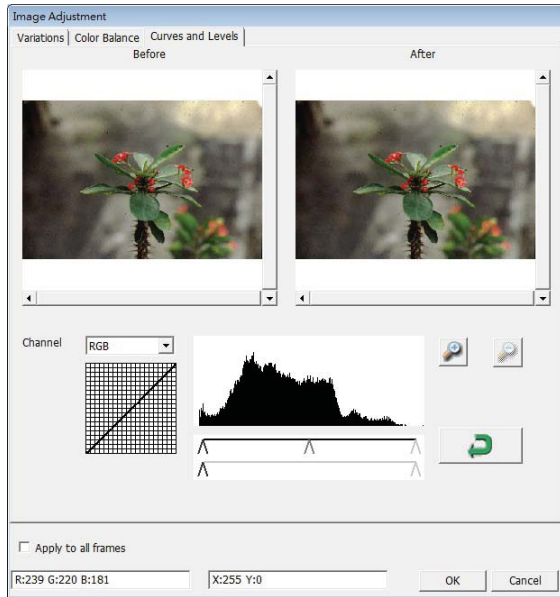

Example: When the previewed image appears to be too dark, adjustments with the Input slider in the Curves and Levels window can be made to correct the image. Selecting the Gray slider in the center and moving it to the left will result in changes in the "After" view resulting in a lighter image. Once the adjusted image is acceptable select "OK" to send changes to the scanning hardware. The same method can also be used to adjust each color channel independently, using the channel drop down menu "RGB = All colors" R = Red, G = Green, and B = Blue.

Menu Commands - Window

1. Exposure Setting: To adjust the exposure time (R, G, B) press "Reset" to restore to the default setting.

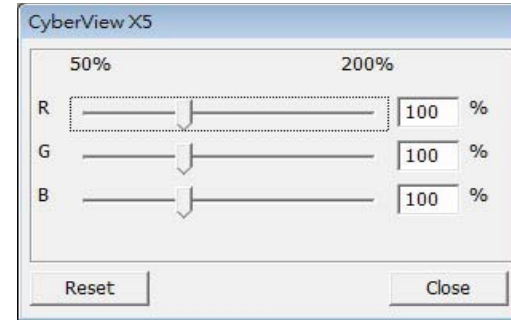

Menu Commands - Help

- **Update:** Firmware: Upgrade the firmware version, select the path where the file of firmware has been saved. (These files may be downloaded from our website)
- **About:** Displays system information (including operation system, CPU), product information (including product name, model name, hardware version, firmware version, software version, device information including interface and optical resolution).



Function Bar Diagram

Please select your film type and brand from the toolbar:

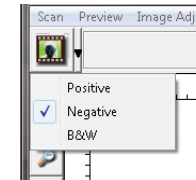
Negative
Positive (also known as Slide)
Black and White







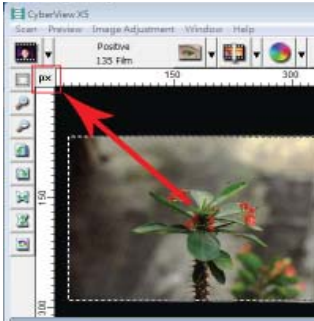



II. Preview Window Area [Fixed Windows]

-  **Prescan:** Pre-scan the current film, press drop down ▼ for more options.
-  **Scan:** Scan film, press drop down ▼ button for more options.
-  **Image Adjustment:** Press drop down ▼ button for more options.



Preview the image you pre-scan, you can select the measurement unit "in"-"cm"-"px" by clicking the upper-left corner.

Toolbar Diagram

-  **Select scan area:** more than one selection can be made at a time.
-  **Zoom In:** To magnify the image where the cursor is currently located. The image will be magnified with every click until the maximum multiple (1000%) is reached.
-  **Zoom Out:** To reduce the size of the viewed image click the Zoom Out cursor to the desired area, the image will reduce by half with every click until the lowest multiple (25%) is reached.
-  **Rotate 90 Left:** To rotate the image counter clockwise 90 degrees.
-  **Rotate 90 Right:** To rotate the image clockwise 90 degrees.
-  **Flip Horizontal:** To Flip the image 180 degrees horizontally.
-  **Flip Vertical:** To Flip the image 180 degrees vertically.
-  **Revert:** Discard all modifications and restores the image back to the original state in preview windows.

Status Line

In the lower left hand corner, the color level (RGB: red, green, blue) and coordinates of the location [ex: I] are displayed. The zoom scale, the current slide magazine location and how many areas selected to scan (2 or or higher indicates: Multiple scan areas on one slide [ex: II]).



III. Scan Setting Area [Floating Windows]

Normal mode [ex: I] to input the basic parameter to scan (including scan resolution, film size, color depth).

Advanced mode [ex: II] to input the parameter of scan output, scan resolution, and color depth

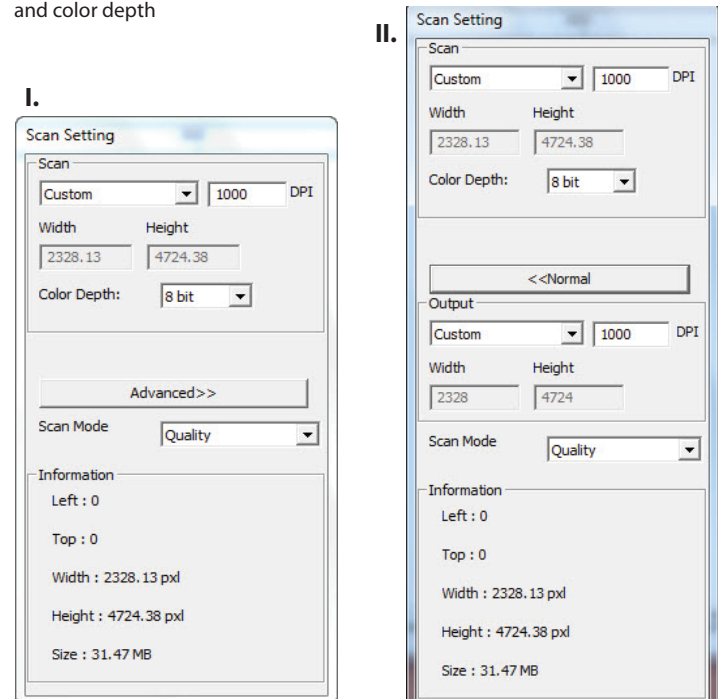

TECHNICAL SUPPORT

CyberView

For information regarding the film scanner and CyberView driver, please visit www.reflecta.de.

Bundled application software

You can refer to the HELP function on the application menu bar or visit the software company's website.

**This user manual has also been archived in the packaged CD.